

PADDY TERRACES

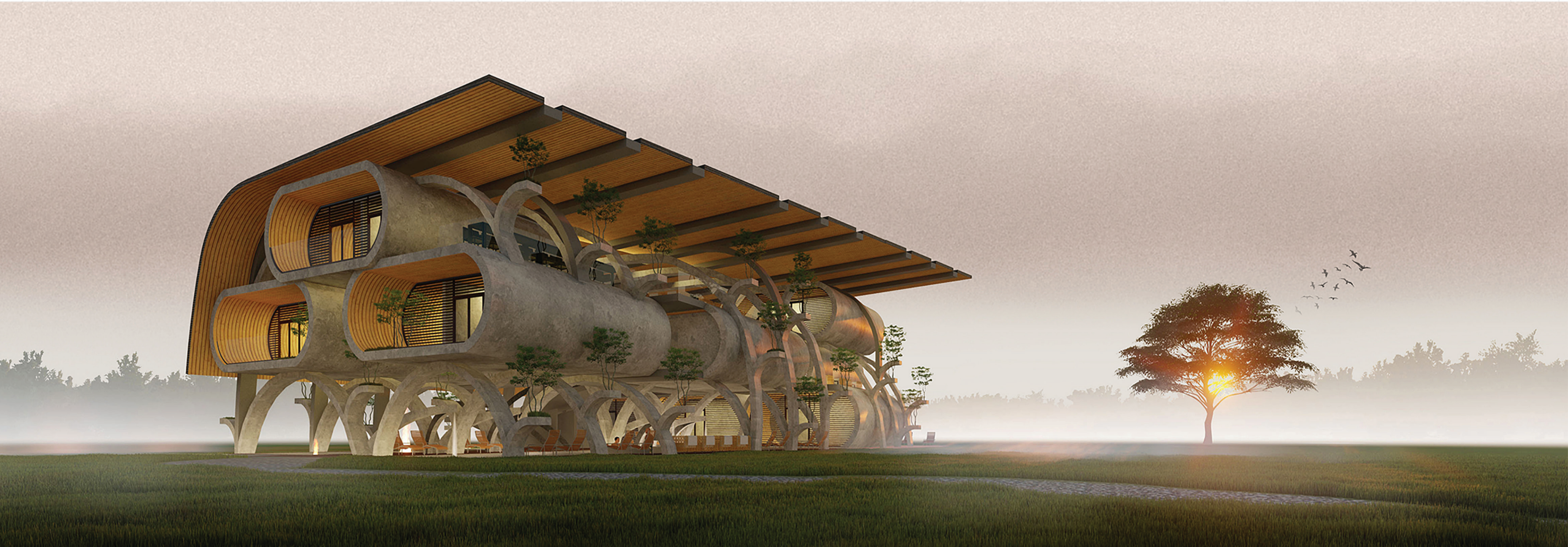

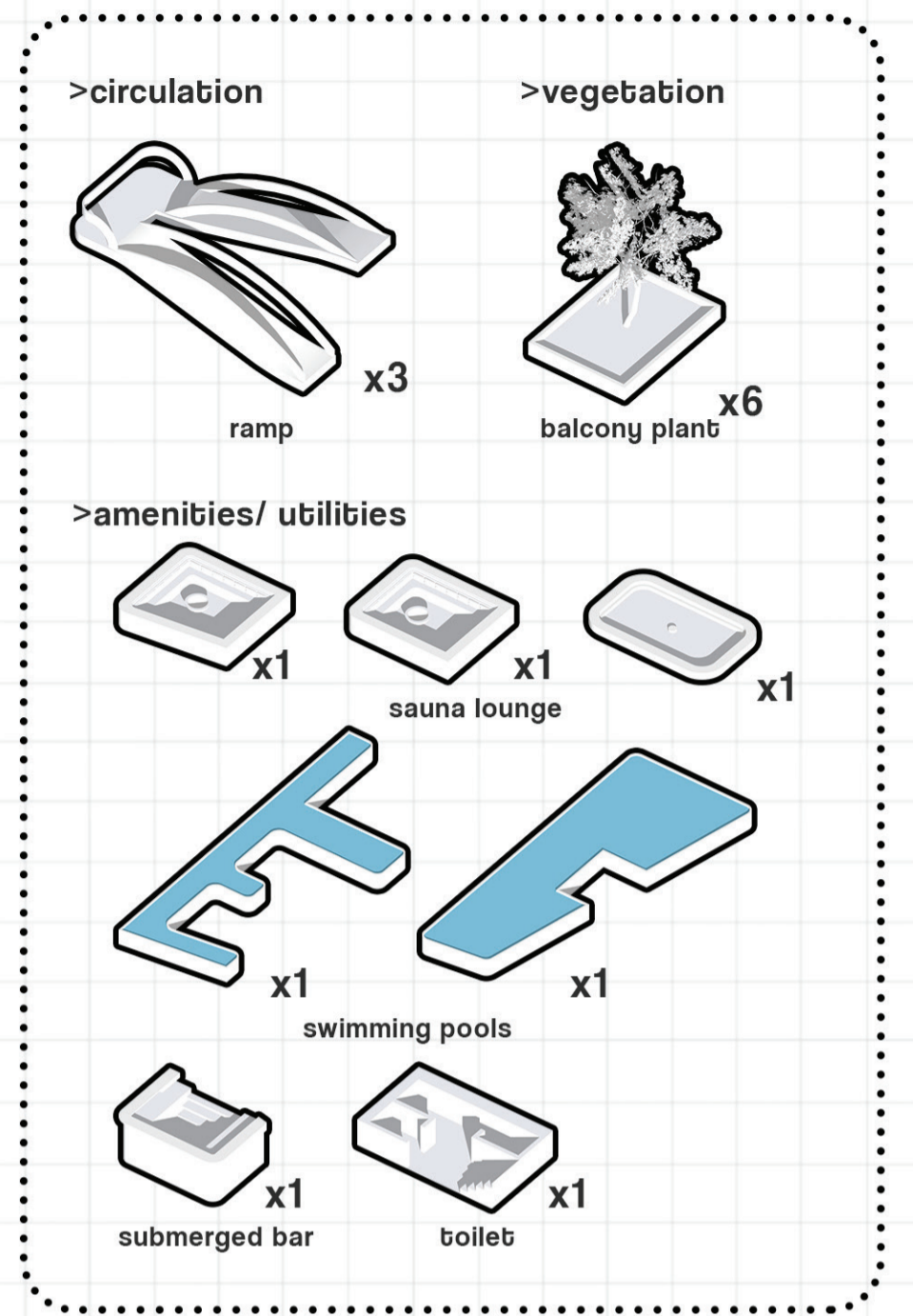
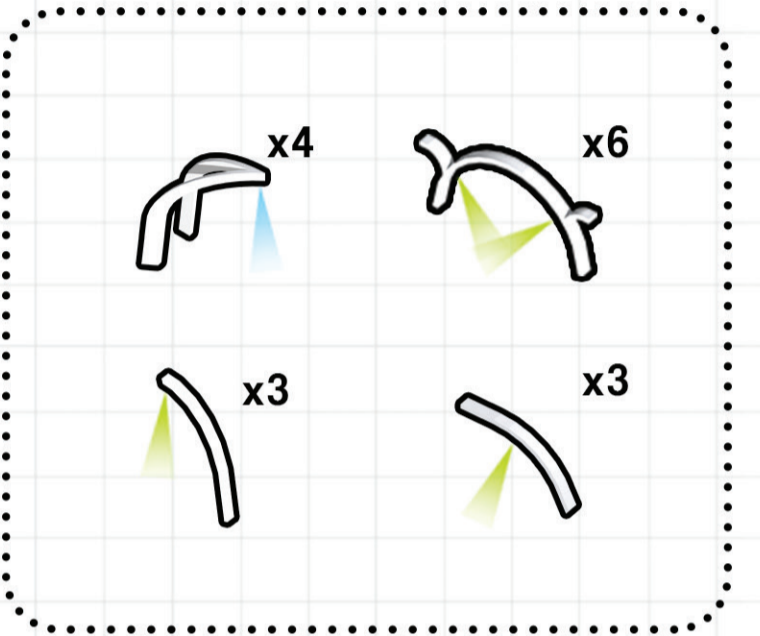
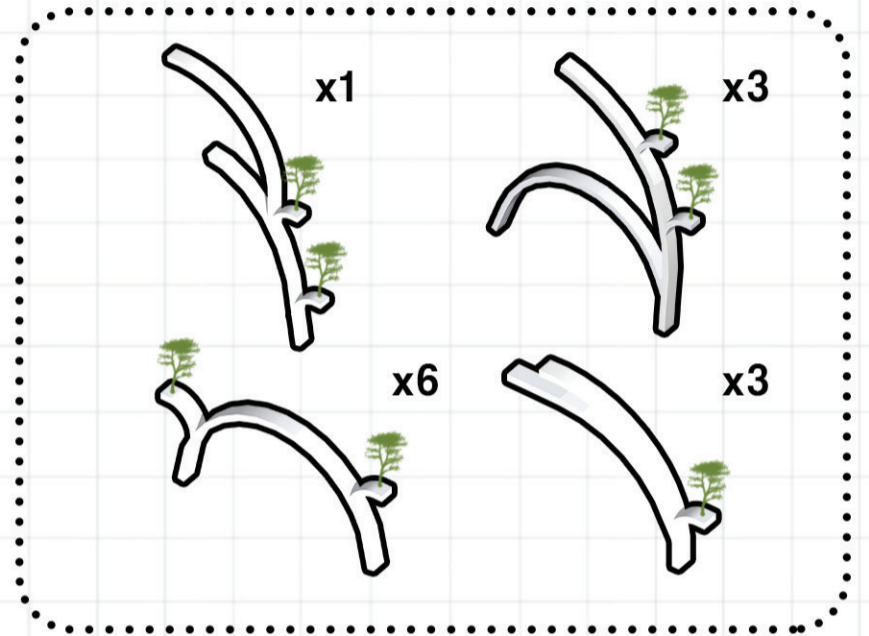
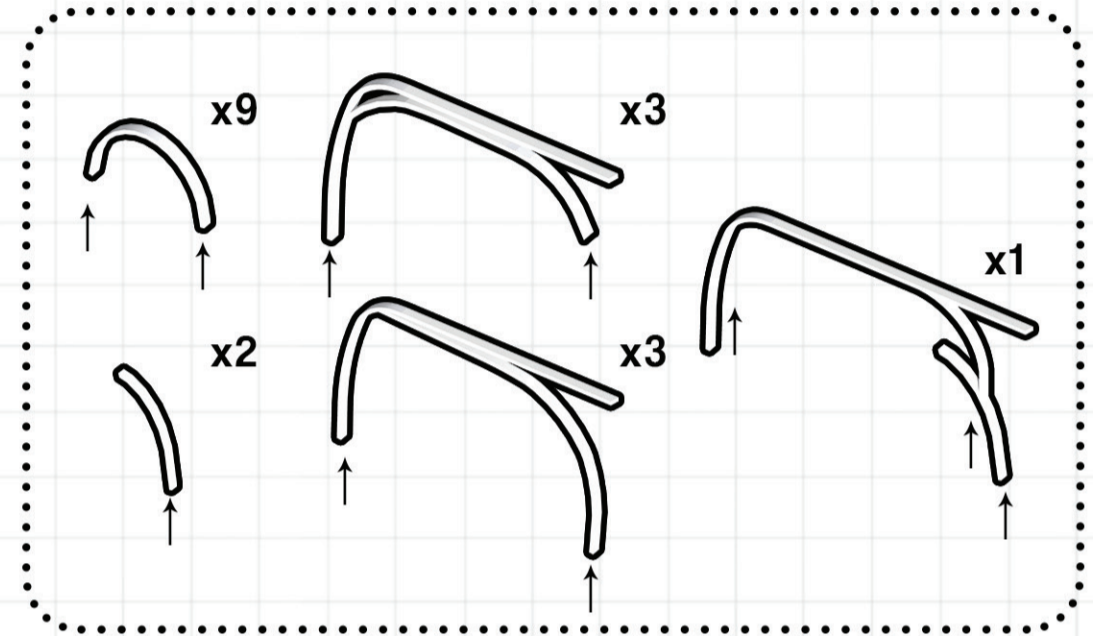
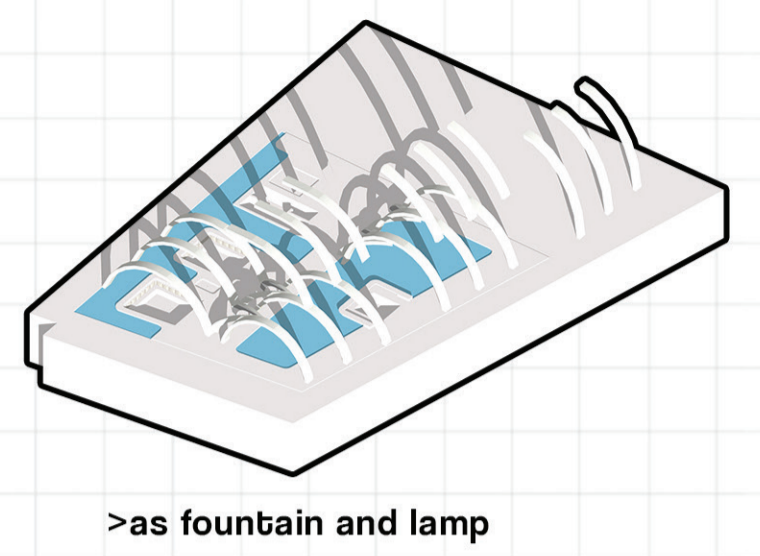
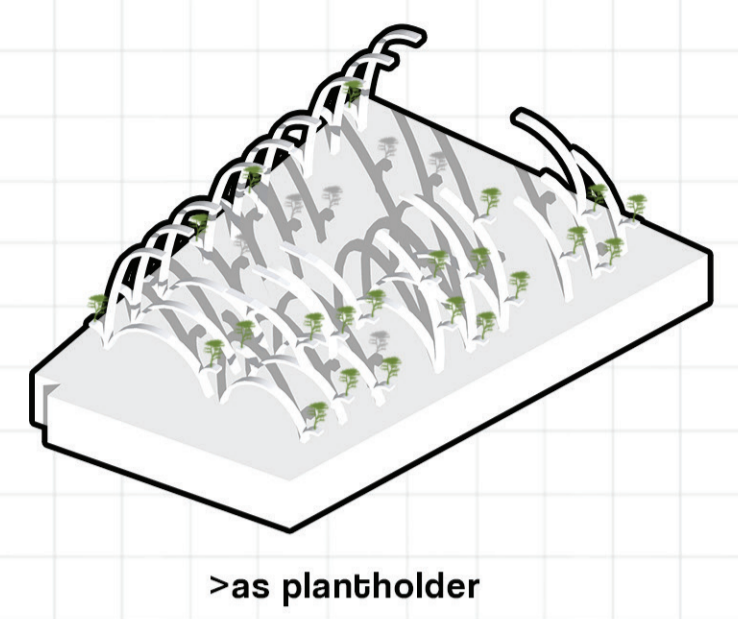
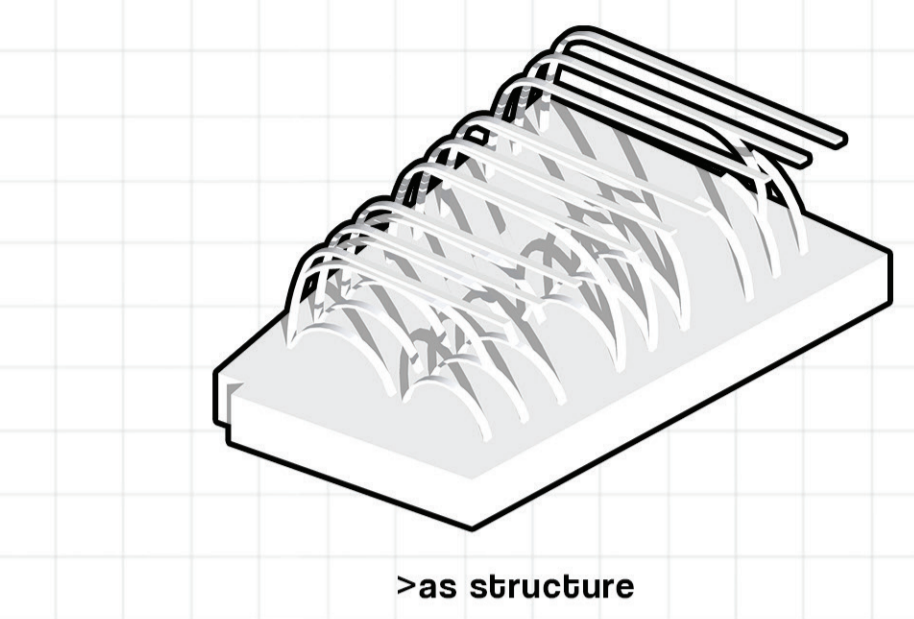
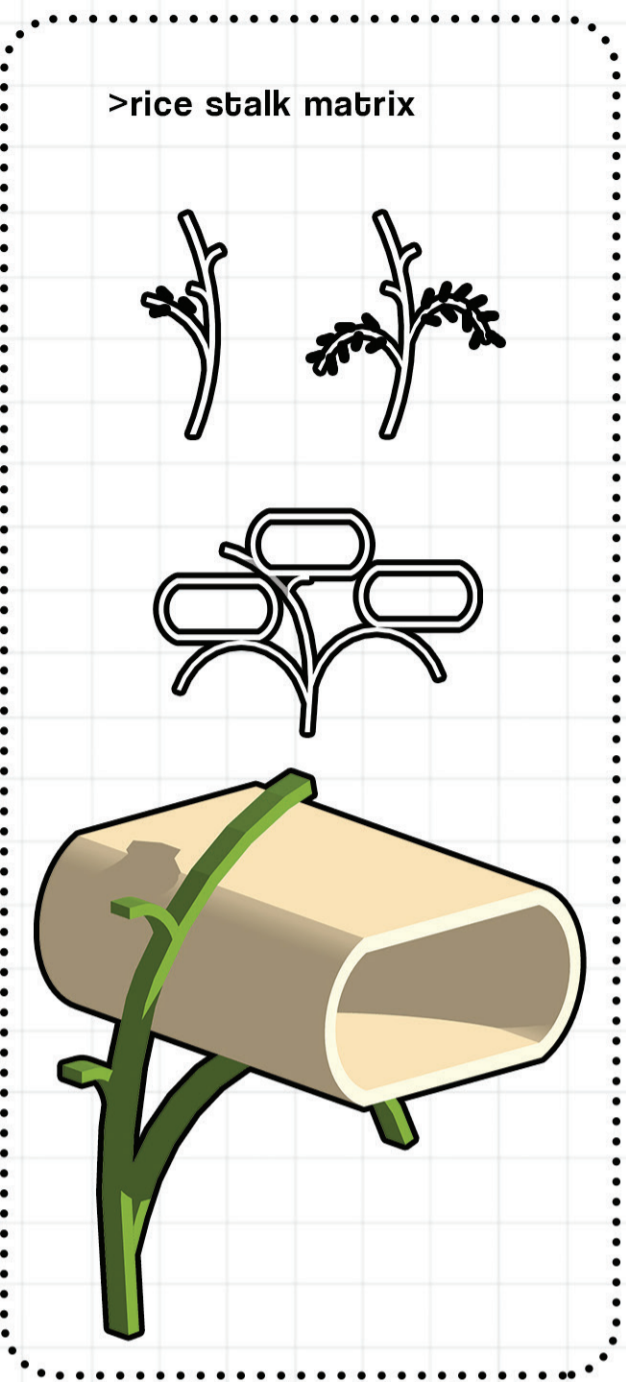
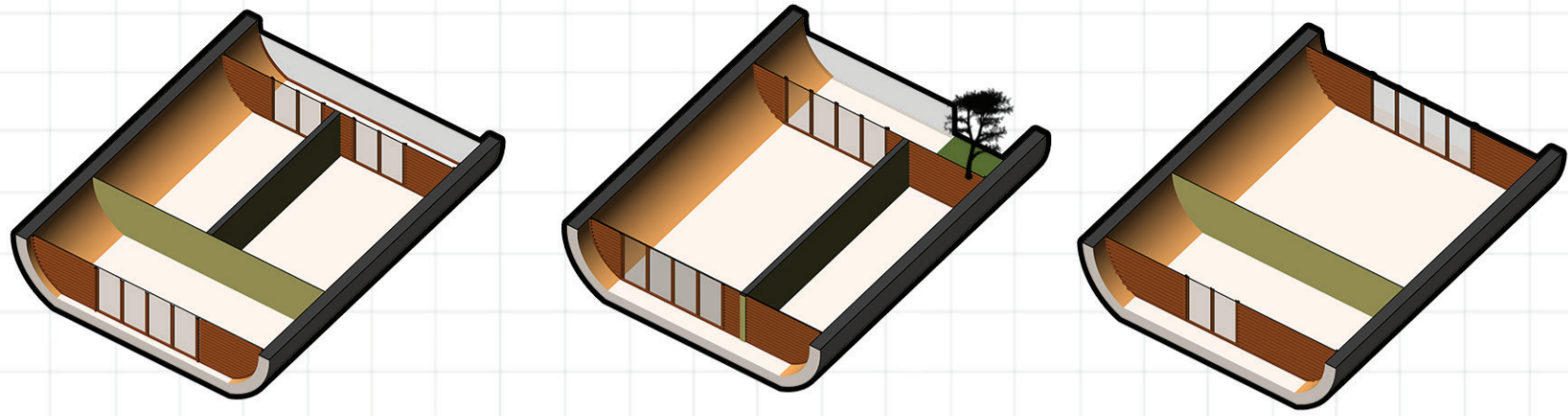

>2 unit module

>medium size unit module

>large size unit module

>room modules toolkit

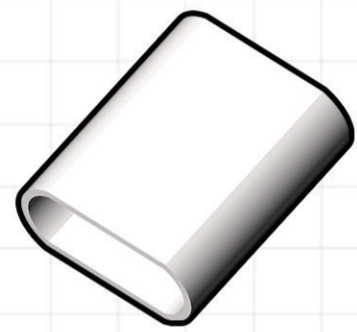

>concrete shell

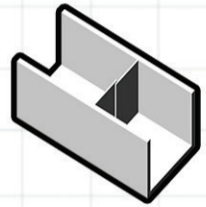

>toilet module 1



>toilet module 2

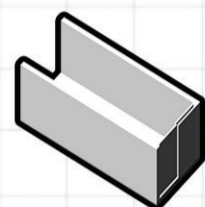

>toilet module 3

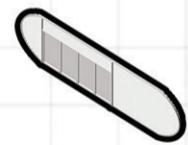

>brise soleil 1

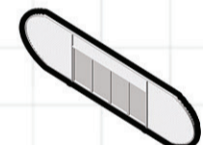

>brise soleil 2

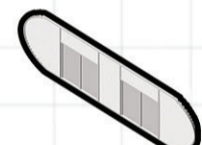

>brise soleil 3

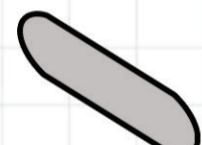

>partition module 1

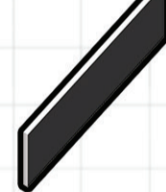

>partition module 2

>axonometric presentation

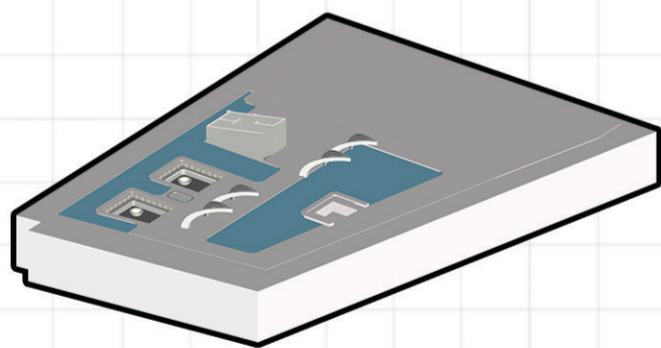

>amenities floor

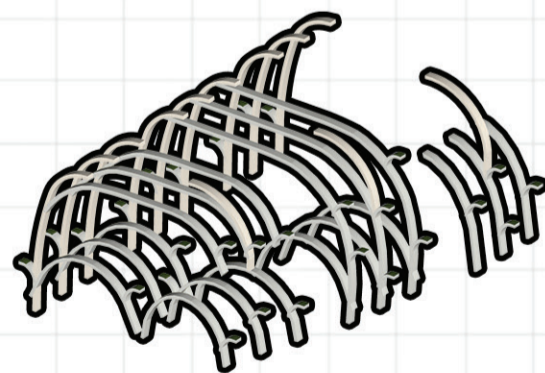

>rice stalk skeleton

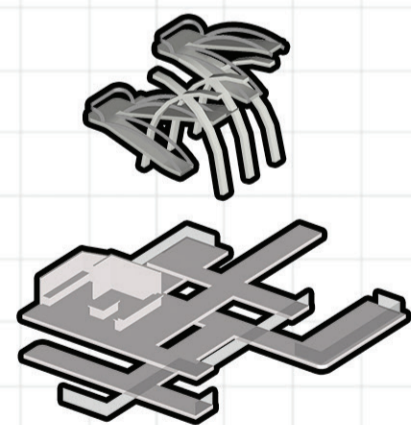

>circulations

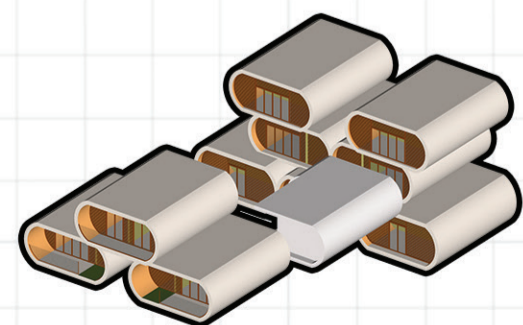

>units stacking

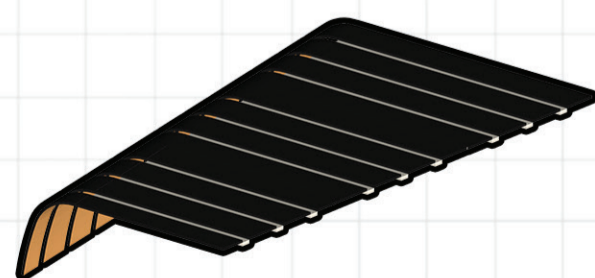

>enveloping roof

